



# ENJOY

## Your QCA Paradise/Majestic Series Spa ML 900 Panel

### OWNER'S MANUAL

This owner's manual is for YOU! It will show you how to operate and maintain your very own spa. We think it is important for you to take a few moments and get acquainted with your new spa operation. Please keep this manual available for references.

QCA Spas would like to congratulate you on your purchase and we sincerely hope you enjoy your QCA Spa.

SERIAL NUMBER \_\_\_\_\_

18 DIGIT SPA NUMBER \_\_\_\_\_



## TABLE OF CONTENTS

<i>Cleaning the Filter Cartridge</i> .....	13
<i>Draining the Water</i> .....	12
<i>Filter Maintenance</i> .....	13
<i>Hydro-, Turbo-, Air-Max<sup>(tm)</sup></i> .....	10
<i>Hyperthermia Description</i> .....	3
<i>Initial Start Up</i> .....	5
<i>Installation Instructions</i> .....	4
<i>115/240v Installations</i> .....	4
<i>Jets, Jets, Jets</i> .....	11
<i>Prevention of Freezing</i> .....	13-14
<i>QCA Spa Light</i> .....	11
<i>Refilling your Spa</i> .....	12
<i>Removing the Filter Cartridge</i> .....	13
<i>Sequencer Controller</i> .....	8
<i>Spa and Cabinet Maintenance</i> .....	14
<i>Spa Location</i> .....	4
<i>Spa Side Control</i> .....	5
<i>Spa Vac Kit</i> .....	12
<i>System Messages</i> .....	7-8
<i>Troubleshooting</i> .....	7-8
<i>UL Instructions</i> .....	3
<i>Vacation Care</i> .....	13
<i>Warranty</i> .....	14
<i>Warranty Card</i> .....	15
<i>Water Care Program</i> .....	12
<i>Winterizing</i> .....	14

## UL INSTRUCTIONS

*The instructions you are about to read are required to be published in your manual by the Underwriters Laboratories. These instructions are very important for your safety and QCA would like to encourage you to read and apply all instructions. Thank you!*

### IMPORTANT SAFETY INSTRUCTIONS

*When installing and using this electrical equipment, remember to always observe safety precautions, including the following:*

1. READ AND FOLLOW ALL INSTRUCTIONS.
- 2a. DANGER - To reduce the risk of injury, do not permit children to use this product unless they are closely supervised.
- 2b. WARNING - RISK OF CHILD DROWNING. Extreme caution must be exercised to prevent unauthorized access by children. To avoid accidents, ensure that children cannot use a spa or hot tub unless they are supervised at all times.
3. Connect to a grounded, grounding type receptacle only.
4. WARNING - To reduce the risk of electrical shock, replace a damaged cord immediately.
5. DANGER - To reduce the risk of injury to persons, do not remove suction fittings.
6. A pressure wire connector is provided on the inside and outside of the control box inside the unit to permit connection of a minimum No. 8 AWG (8.4mm) solid copper bonding conductor between this point and any metal equipment, metal enclosures of electrical equipment, metal water pipe, or conduit within 5 feet (1.5m) of the unit as needed to comply with local requirements.
7. (All permanently installed units must have a GFCI) This appliance must have a neutrally protected ground-fault circuit-interrupter. Before each use and with the unit operating, push the test button. The unit should stop operating and the reset button should appear. Push the reset button. The unit should now operate normally. If the interrupter does not perform in this manner, a ground current is flowing indicating the possibility of an electric shock. Disconnect the power until the fault has been identified and corrected.
8. Install to provide drainage of compartment for electrical components.
9. **RISK OF ELECTRIC SHOCK.** Install at least 5 feet (1.5m) from all metal surfaces. (A spa may be installed within 5 feet of metal surfaces if each metal surface is permanently connected by a minimum No. 8 AWG (8.4mm) solid copper conductor attached to the pressure wire connector on the terminal box that is provided for this purpose.)
10. DANGER - RISK OF ELECTRICAL SHOCK. Do not permit any electrical appliance, such as a light, telephone, radio, or television, within 5 feet (1.5m) of the spa or hot tub.
11. To reduce the risk of injury:
  - a. The water in a spa or hot tub should never exceed 40°C (104°F). Water temperatures between 38°C (100°F) and 40°C (104°F) are considered safe for a healthy adult. Lower water temperatures are recommended for extended use (exceeding 10-15 minutes) and for young children.
  - b. Since excessive water temperatures have a high potential for causing fetal damage during the early months of pregnancy, pregnant or possibly pregnant women should limit spa or hot tub water temperatures to 38°C (100°F).
  - c. Before entering a spa or hot tub, the user should measure the water temperature with an accurate thermometer since the tolerance of water temperature-regulating devices may vary as much as +/-3°C (5°F).
  - d. The use of alcohol, drugs, or medication before or during spa or hot tub use may lead to unconsciousness with the possibility of drowning.
  - e. Persons suffering from obesity or with a medical history of heart disease, low or high blood pressure, circulatory system problems or diabetes should consult a physician before using a spa or hot tub.
  - f. Persons using medication should consult a physician before using a spa or hot tub since some medication may induce drowsiness while other medications may affect heart rate, blood pressure, and circulation.
12. The electrical supply for this product must include a suitably rated switch or circuit breaker to open all ungrounded supply conductors to comply with section 422-20 of the National Electrical Code, ANSI/NFPA 70-1987. The disconnecting means must be readily accessible to the tub occupant but installed at least 5 feet (1.5m) from the tub water. For units used in other than single-family dwellings, a clearly labeled emergency switch shall be provided as part of the installation. The switch shall be readily accessible to the occupants and shall be installed at least 5 feet (1.52 m) away, adjacent to, and within sight of the unit.

### SAVE THESE INSTRUCTIONS

#### Just a quick note,

*For your own security...Prolonged immersion in water that is warmer than normal body temperature can result in a dangerous condition known as HYPERTHERMIA. The causes, symptoms, and effects of hyperthermia may be described as follows: Hyperthermia occurs when the internal temperature of the body reaches a level several degrees above the normal temperature of 98.6°F or 37°C. The symptoms of hyperthermia include dizziness, fainting, drowsiness, lethargy, and an increase in the internal temperature of the body. The effects of hyperthermia include (1) unawareness of impending hazard, (2) failure to perceive heat, (3) failure to recognize the need to exit the spa, (4) physical inability to exit the spa, (5) fetal damage in pregnant women, and (6) unconsciousness resulting in a danger of drowning.*

*WARNING - the use of alcohol, drugs, or medication can greatly increase the risk of fatal hyperthermia in hot tubs and spas.*

## **Spa Location**

*The selection of a site for the installation of your spa is a very important decision and should be undertaken keeping several factors in mind.*

1. Always check your local codes before installing your spa. A clear understanding of buildings, fences, gates, electrical and plumbing guidelines will be invaluable.
2. Select a location that will compliment your lifestyle and your home. The spa will become an integral part of your life and therefore should be placed advantageously.
3. The position of the spa in relation to surrounding terrain should be considered. Locating the spa near or directly under trees not only cuts off the sun thereby depriving you of natural heat, but also necessitates the physical removal of leaves and debris. Airborne dirt and debris may also be carried into the spa by prevailing winds. In addition, an uncovered spa with wind blowing across the top will tend to lower water temperatures; therefore you may wish to shield your spa from direct winds.
4. You may wish to consider an indoor installation. An indoor spa located off of a bedroom or family room can offer relaxing solitude or enjoyable gatherings of friends or family. Care should be taken in providing protection from possible water damage due to splashing. High humidity levels relating to the spa can also be a source for damage and should be planned for in the construction stage.
5. Your portable spa with a cabinet has been designed to be self-supporting. Any further reinforcement or support is not required when placed upon a sound foundation. In order to prevent damage to the cabinet and spa be certain to locate the spa on a solid, level foundation capable of maintaining the weight of the spa when filled with water.
6. A base of poured concrete is best for this type of installation. You may wish to use an existing patio but if you wish to construct a new base for your spa, select a level, flat area. After removing the topsoil, construct a square frame using four 2x4's. Usually an area ten square foot will suffice. When the frame has been leveled, pour a 3 1/2" base of concrete mix into the frame leveling the mix by stroking across the top with another 2x4. Finish the top with the cement float. When the slab has cured remove the 2x4's and landscape as desired. Note: It is necessary to provide drainage of the compartment for the electrical components.
7. Install your spa in a location, which allows easy access to the equipment bay.
8. Before filling with water, be sure the spa is in its final position and that hoses, tools, etc. are not under the spa.

## **Installation Instructions**

### *Electrical-General*

Prior to performing any service to the spa package turn OFF ALL primary electric power at the main circuit breaker or disconnect panel.

Opening the front cover of the electrical control box can make all field electrical connections.

All electrical connections to this spa package must be accomplished by a qualified electrician in accordance with the National Electric Code or the Canadian Electric Code and in accordance with any local electrical codes in effect at the time of installation.

All connections should be made in accordance with the wiring tab enclosed in the electrical control box.

These spa packages are designed to operate on 60Hz Alternating Current only, at a voltage of 240 volts.

Spa packages with a 240-volt rating require a three wire electrical service, plus ground (line 1, line 2, neutral and ground).

Connections should be made using copper conductors only. The connecting wire and circuit breakers or fuses must be sized to accommodate the Total Ampere load as specified on the equipment module data label.

A bonding lug has been provided on the equipment module to allow connection to local ground points. To reduce the risk of electrical shock, a #8 AWG solid copper bonding wire should be run from this lug to any metal ladders, water pipes or other metal within 5 feet of the spa.

**PLEASE NOTE: To Overseas owners**

50 Hz, 230-volt units should be wired to the national code in the country of the owner's residence.

## **240 volt Installation**

Units to be operated at 240 volts must have all electrical connections accomplished by a qualified electrician in accordance with the National Electric Code, the Canadian Electric Code or other local electrical codes in effect at the time of installation.

Equipment modules installed for 240-volt operation requires a three wire electrical service, plus ground (line 1, line 2, neutral and ground). Refer to terminal block diagram.

## **Starting the Spa**

1. Fill the spa to at least minimum water level (indicated near the skimmer) before electrical power is turned on.
  - Be sure all valves and hose bib, located on power pack, are closed and all union nuts are tight.
2. Check for plumbing leaks.
3. Be sure all suction valves to the equipment pack are open.
4. Open return valve with handle in up position.
5. Set filtering cycles according to control panel instructions.

# Paradise/Majestic Series



## Initial Start-up



Majestic and Paradise have the same buttons, only difference is logo

When your spa is first powered up, it will automatically heat and maintain 100°F until you change the set temperature. In the event of a power failure or during a manual shutdown, the spa will revert to the last set temperature, mode, and filter cycle before the loss of power once power is restored.

Self Diagnosis/Priming mode of spa takes six minutes. Four minutes after power-up "- -" will appear for two minutes. Spa will then enter first filter cycle and is now available to set.

**DO NOT DISTURB** during the six-minute self-diagnostic procedure.

## Icon Legend

 Heat Icon - Indicates different stages of heating.  
 Jets Icon - Spins fast on high-speed spins slow on low speed.  
 Blower Icon - Biggest in highest speed; smallest in lowest speed.

 Fiber-Optic Light Icon – Spins when the wheel is on; stands still when wheel is off.

 Light Icon - On dim, the LCD will show the center circle plus one quarter of the light beams. Half of the light beams will show on medium brightness, and all of the light beams will show on bright.

## Temp Set (80°F - 104°F / 26.0°C - 40.0°C)

The start-up temperature is set at 100°F/37.5°C. The last measured temperature is constantly displayed on the LCD.

Press the “Warm” or “Cool” button once to display the set temperature. Each time either button is pressed again, the set temperature will increase or decrease depending on which button is pressed. After three seconds, the LCD will automatically display the last measured spa temperature.

Note that the last measured spa temperature displayed is current only when the pump has been running for at least 2 minutes.

## Setting the Time

When time hasn’t been programmed, the TIME icon flashes.

Press Time and then the Mode/Prog button.

Select the hour by pressing the warm or cool arrows. Each press changes the time by 1 hour.

Select minutes by pressing the Mode/Prog once again followed by the warm or cool arrows. Each press changes the time by 1 minute.

Press the Mode/Prog to exit the time setting procedure and enter the optional filter cycle programming.

## Mode/Prog

This button is used to switch between standard, economy, and sleep modes. Press “Mode/Prog” to enter mode programming, press “Cool” to cycle through to desired mode (LCD flashes until confirmed), then press “Mode/Prog” to confirm selection.

**Standard mode** maintains the desired temperature. The “STANDARD” icon will display until the mode is changed.

**Economy mode** heats the spa to set temperature only during filter cycles. The “ECONOMY” icon will display until mode is changed.

Pressing “Jets 1” while in Economy mode puts the spa in Standard-In-Economy mode, which operates the same as Standard Mode, then reverts to Economy Mode automatically after 1 hour. During this time, a press of the “Mode/Prog” button will revert to Economy Mode immediately.

**Sleep mode** heats the spa to within 20°F (11°C) of the set temperature only during filter cycles. The “SLEEP” icon will display until mode is changed.

## Standby Mode

Pressing “Warm” or “Cool” then “Jets 2” will turn off all spa functions temporarily. This is helpful when changing a filter.

Press any button to exit Standby mode.

## Jets 1

Press the “Jets 1” button once to turn pump 1 on, again to switch to high-speed. Pressing for a third time turns pump 1 off. If left running, the low speed turns off after 2 hours and the high speed turns off after 15 minutes.

The low-speed of pump 1 runs when the blower or any other pump is on. It may also activate for at least 2 minutes every 30 minutes to detect the spa temperature (polling) and then to heat to the set temperature if needed, depending upon mode. When the low speed turns on automatically, it cannot be deactivated from the panel; however, the high speed may be started.

## Jets 2

Press the “Jets 2” button once to turn pump 2 on, again to turn on high-speed. Pressing once more, turns off pump 2. If left running, the pump will turn off after 15 minutes.

## Jets 3

Option only available on Ultra XLP model spas. Press the “Jets 3” button once to turn pump 3 on, again to turn on high-speed. Pressing once more, turns off pump 3. If left running, the pump will turn off after 15 minutes.

## Blower

Press the “Blower” button to turn on, twice to turn on low speed, three times to turn on medium speed and a fourth time to turn on high-speed. Pressing once more will turn the blower off.

If left on, the blower will automatically turn off after 15 minutes.

## Temperature Display Inversion

Press the “Invert” button to change the numbers in the display to read upside down. Another press returns the display to its normal right-side-up display.

## Light

Press the “Light” button to turn the spa light on and off, and to shift between dim and bright settings if your light is dimmable. On dim, the LCD will show center circle plus one quarter of the light beams. Half of the light beams will show on medium brightness, and all of the light beams will show on bright.

## LED Lighting

If LED lighting is installed press the “Light” button to start the unit. To change colors or modes, press the “Light” button off and on to cycle

the unit. If the light or LED unit is left on, it will automatically turn off after 4 hours.

## OPTIC

Button is not used for this model.

## Preset Filter Cycles

On all systems, the pump and the ozone generator will run during filtration. At the start of each filter cycle, the blower will run on highest speed for 30 seconds to clean out the air channels. The low-speed of pump 2 will run for 5 minutes.

There are two filter cycles per day. The start/end times of each cycle are programmable. To program, set time as instructed above, then press “Mode/Prog” to advance to the next setting (or to exit after the last setting). The default filter cycles are as follows:

The first filter cycle is automatically activated at 8:00 AM and operates the pump until 10:00 AM. The filter 1 indicator icon will light when filter 1 is running.

The second filter cycle is automatically activated at 8:00 PM and operates the pump until 10:00 PM. The filter 2 indicator icon will light when filter 2 is running.

## Optional Filter Cycle Programming

You are not required to set filter cycles; however, it is an option available to you. To change the filter cycle settings:

Press “Time” “Mode/Prog” “Mode/Prog” “Mode/Prog” within 3 seconds. You will see the “SET FILTER 1” and a flashing “START TIME” icon appear on the display.

Press “Up” or “Down” to choose the filter start time hour. Enter the hour by pressing “Mode/Prog”. Press “Up” or “Down” to choose the filter start time minutes. Each press changes the start time by 5 minutes.

Enter the minutes by pressing “Mode/Prog.”

Press “Mode/Prog” to see the “SET FILTER 1” and a flashing “END TIME” icon. Adjust the time as done above.

Press “Mode/Prog” to see the “SET FILTER 2” (PM cycle) and a flashing “START TIME” icon. Proceed as above.

Press “Mode/Prog” to see “SET FILTER 2” and a flashing “END TIME” icon. Adjust the time as done above.

Pressing “Mode/Prog” will enter the new filter cycle times into the system and display the current water temperature.

*Pressing “Time” at any time during this programming sequence will save the values entered up to that point and exit programming.*

If you would like to select continuous filtration, set the filter 1 start and end times to be the exact same time.

similarly except t\with the temperature thresholds determined by the switch and without a 4-minute delay in turnoff. See you dealer for details.

### Clean-up Cycle

When the pump or blower is turned on by a button press, a clean-up cycle begins 30 minutes after the pump or blower is turned off or times out. The pump and the ozone generator\*\* will run for one hour.

### Freeze Protection

If the temperature sensors detect a drop to 44° F (approximately 6.7° C) within the heater, then the pump automatically activates to provide freeze protection. The equipment stays on until 4 minutes after the sensors detect that the spa temperature has risen to 45° F (approximately 7.2°C) or higher. In colder climates, an optional additional freeze sensor may be added to protect against freeze conditions that may not be sensed by the standard sensors. Aux freeze sensor protection acts

### Locking the Panel

Press “Time” “Jets 1” then the “Warm” within 3 seconds. When locked the PL indicator light will light. All buttons are frozen except the “Time” button. To unlock panel, press “Time” “Jets 1” then “Cool.”

### Locking the Temperature

Press “Temp+/-” “Time” “Jets 1” then the “Temp+” within 3 seconds to lock the temperature. When locked the PL indicator light will light. All buttons are frozen except the “Temp” button. To unlock panel, press “Temp+/-” “Time” “Jets 1” then “Temp-.”

Please Note: In multi-button sequences, if buttons are pressed too quickly in sequence, they may not register.

### Diagnostic Messages

Message	Meaning	Action Required
	No Message on display. Power has been cut off to the spa.	The control panel will be disabled until power returns. Spa settings are preserved on all systems.
<b>HTR TEMP LMT</b>	“Overheat” - The spa has shut down. On some systems, an alarm may sound. One of the sensors has detected 118°F (approximately 47.8°C) at the heater.	DO NOT ENTER THE WATER. Remove the spa cover and allow water to cool. Once the heater has cooled, reset by pushing any button. If spa does not reset, shut off the power to the spa and call your dealer or service organization.
<b>SPA TEMP LMT</b>	“Overheat” - The spa has shut down. One of the sensors has detected that the spa water is 110°F (approximately 43.3°C).	DO NOT ENTER THE WATER. Remove the spa cover and allow water to cool. At 107°F (approximately 41.7°C), the spa should automatically reset. If spa does not reset, shut off the power to the spa and call your dealer or service organization.
<b>FREEZE COND</b>	“Ice” - Potential freeze condition detected.	No action required. The pumps and the blower will automatically activate regardless of spa status.
<b>SENSOR A SERVICE RQD</b>	Spa is shut down. The sensor that is plugged into the Sensor “A” jack is not working.	If the problem persists, contact your dealer or service organization. (May appear temporarily in an overheat situation and disappear when the heater cools.)
<b>SENSOR B SERVICE RQD</b>	Spa is shut down. The sensor that is plugged into the Sensor “B” jack is not working.	If the problem persists, contact your dealer or service organization. (May appear temporarily in an overheat situation and disappear when the heater cools.)
<b>SENSOR SYNC</b>	Sensors are out of balance. If displayed by itself, it may just be a temporary condition.  If it also says “SERVICE REQ'D,” spa is shut down.	If the problem persists, contact your dealer or service organization.
<b>HTR FLOW LOW</b>	A substantial difference between the temperature sensors was detected. This could indicate a flow problem.	Check water level in spa. Refill if necessary. If the water level is okay, make sure the pumps have been primed. If problem

		persists, contact your dealer or service organization.
<b>LOW FLOW</b>	Persistent low flow problems. (Occurs on the third occurrence of the “HTR FLOW LOW” message.) Heater is shut down, but other spa functions continue to run normally.	Follow action required for “HTR FLOW LOW” message. Turn spa off then back on again to restore heating capability.
<b>HEATER MAY BE DRY – WILL RESET SHORTLY</b>	Inadequate water detected in heater.	Check water level in spa. Refill if necessary. If the water level is okay, make sure the pumps have been primed. Press any button to reset.
<b>HEATER DRY SERVICE RQD</b>	Inadequate water detected in heater. Displays on third occurrence of “HEATER MAY BE DRY - WILL RETEST SHORTLY” message.) Spa is shut down.	Follow action required for “HEATER MAY BE DRY - WILL RETEST SHORTLY” message. Spa will not automatically reset; you may press any button to reset.
<b>PRIMING MODE TAKES 4 MIN</b>	When your spa is first actuated, it will go into Priming mode.	The Priming mode will last for up to 4 minutes and then the spa will begin to heat the spa and maintain the water temperature in the Standard mode.
<b>--F° or --C°</b>	Temperature Unknown.	After the pump has been running for 2 minutes, the temperature will be displayed.
<b>----</b>	Temperature not current in Economy or Sleep Mode.	In Economy or Sleep mode, the pump may be off for hours outside a filter. If you wish to see the current spa temperature, either switch to Standard mode or turn Jets1 on for at least two minutes.
<b>STANDARD MODE</b>	Standby Mode has been activated by pressing a button combination on user panel.	Press any button to leave Standby Mode and return operation.

**Periodic Reminder Messages** (“Press the Mode” button to reset a displayed message)

<b>Message</b>	<b>Frequency</b>	<b>Action Required</b>
<b>CLEAN FILTER</b>	Every 30 days	Remove, clean, and reinstall filter per manufacturer’s instructions.
<b>TEST GFCI</b>	Every 30 days	Test & reset GFCI per manufacturer’s instructions.
<b>DRAIN WATER</b>	Every 90 days	Drain and refill spa per manufacturer’s instructions.
<b>CLEAN COVER</b>	Every 180 days	Clean and condition cover per manufacturer’s instructions.
<b>TREAT WOOD</b>	Every 180 days	Clean and condition cover per manufacturer’s instructions.
<b>NEW FILTER</b>	Every 364 days	Install new filter.



## Operating instructions for Ultra Wave Lounge™:



### To start your sequencer:

Press on/off key to turn sequencer on. The system will then perform an indicator light test and open all valves. Pressing a second time will turn sequencer off. A built-in timer automatically turns sequencer off after 2 hours, unless manually deactivated first.

### To select and preview a sequence:

Press sequences key to select one of the 7 preprogrammed massage sequences. Note that only the first 6 sequences have corresponding indicator lights. The 7th sequence is where all valves are opened at the same time, and does not have an indicator light. A preview of the massage is displayed for 5 seconds after selecting a sequence.

### To change sequence speed:

Press speed key to change the time interval between each step of the selected massage sequence:

Speed 1: 15 seconds between each step.

Speed 2: 10 seconds between each step.

Speed 3: 5 seconds between each step.

The corresponding indicator light flashes to reflect the selected steps.

### To pause a massage sequence:

Press pause key to interrupt a massage sequence and prolong the action of a jet set (or a combination of sets). Pressing a second time will resume the massage sequence. The "Pause" indicator light will be on in Pause mode.

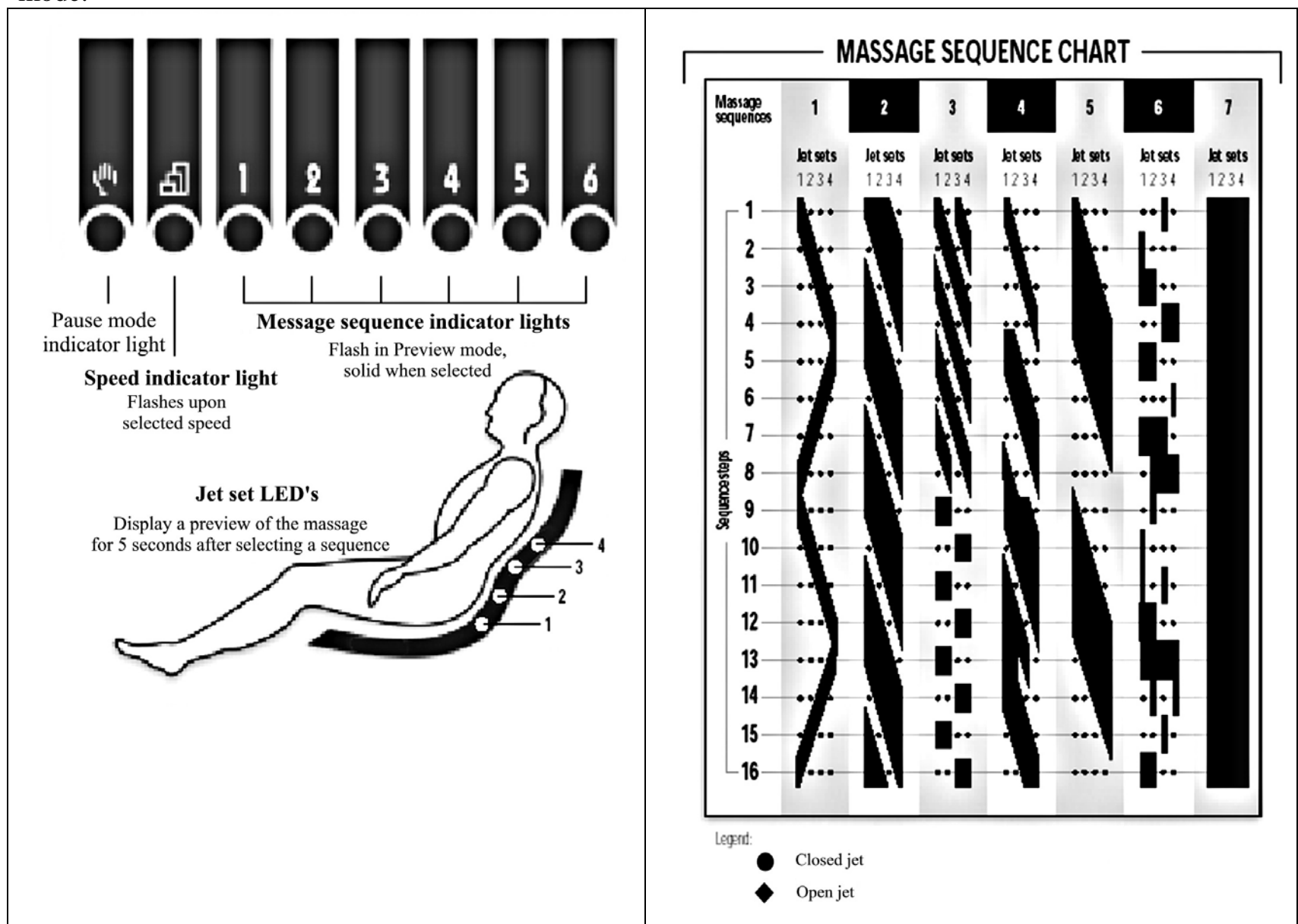

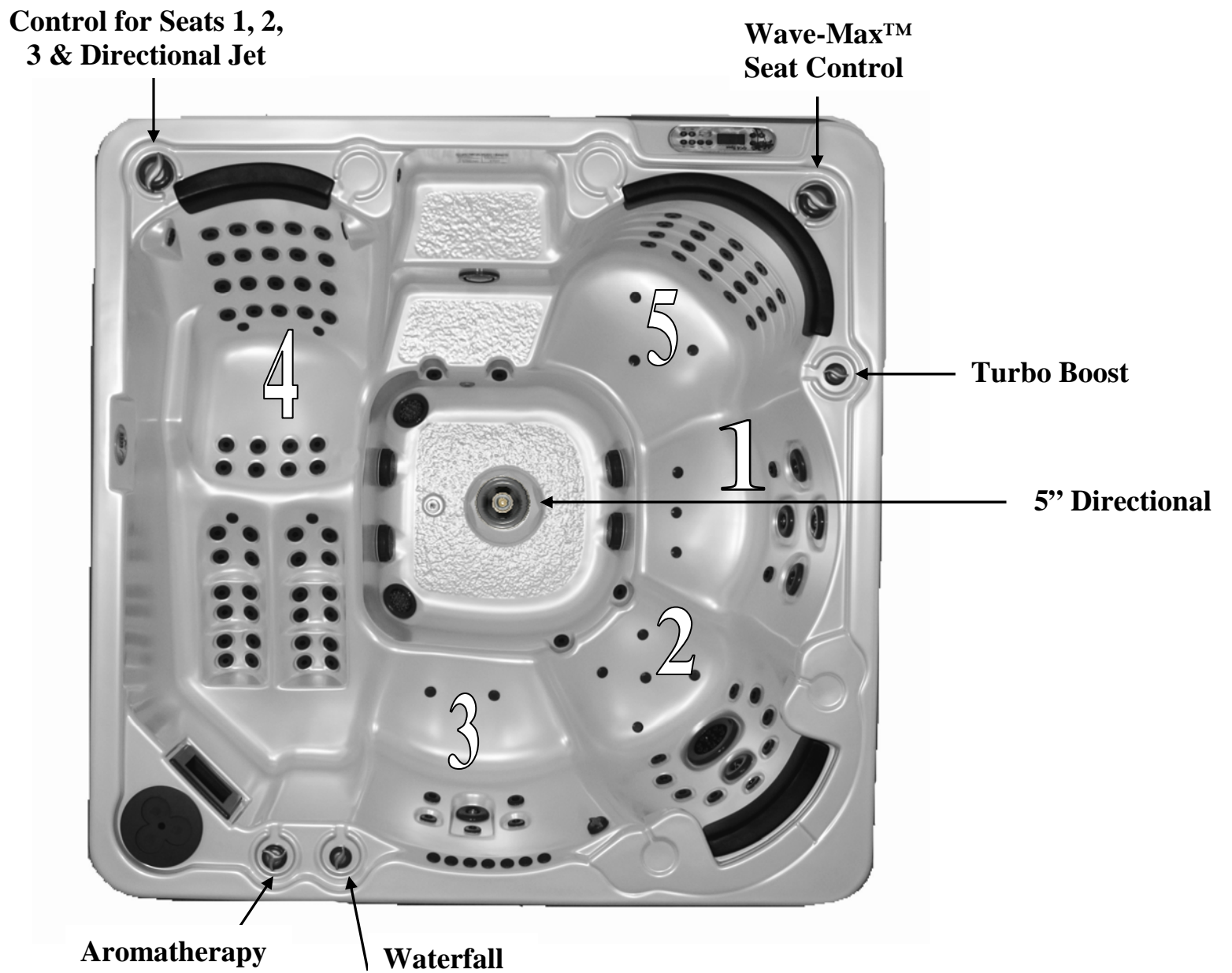

**Wave-Max™ Seat (#5) & Ultra™ Wave Lounger (#4)**

These seats operate off Jets #2. The power can be diverted from Wave Max seat to Ultra Wave Lounger by rotating the diverter valve at the top of the Wave Max seat. To increase the action to these seats turn the blower on and rotate the Turbo Boost valve.

**Hydro-Max Seat™ (#2) & Seats 1 & 3**

Turn on Jets #1. Rotate the diverter valve that separates the Hydro-Max seat and the Volcano Jet until the volcano jet is off. This will allow seat 1, 2 and 3 to operate. To increase the action to these seats turn on the Blower and rotate the Turbo Boost valve.

**Waterfall**

Rotating the waterfall valve counter clockwise will turn on the waterfall.

**Aromatherapy**

Open the canister by turning the cover counter clockwise. Drop in your preferred aromatherapy fragrance beads and replace the cover. Turning the Blower on will circulate the scent.

## Jets



Directional Hurricane Jet-the graphite gray jet is operated by rotating the jet face counter-clockwise in full On position or clockwise for 95% shut-off.



Massage Jet-the graphite gray jet is operated by rotating the jet face counter-clockwise to full On position or clockwise for 95% shut-off. This is a 14 port large volume jet.



Vari-Swirl Jet-the graphite gray jet is operated by rotating the jet face counter-clockwise to full On position or clockwise for 95% shut-off. The Directional and Vari-Swirl Jet is interchangeable. Ask you QCA Dealer for more information.

## Spa Light

All equipment Modules have a receptacle, located on the side of the Equipment Module. This receptacle is provided for the connection of the spa light.

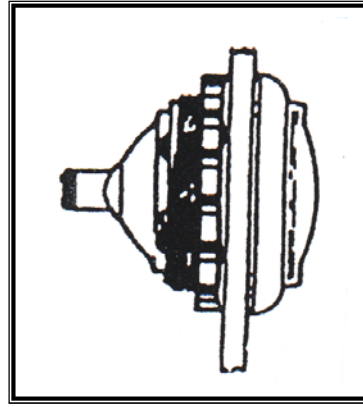

Your QCA Majestic™ Spa has a standard 12v light. The Spa light may be turned ON or OFF by pressing the Light button located on the spa side control.

## Spa Light Lens Installation

Colored lenses are included with the spa light. To install or remove lenses simply push ON or pull OFF of the spa light, as show below.

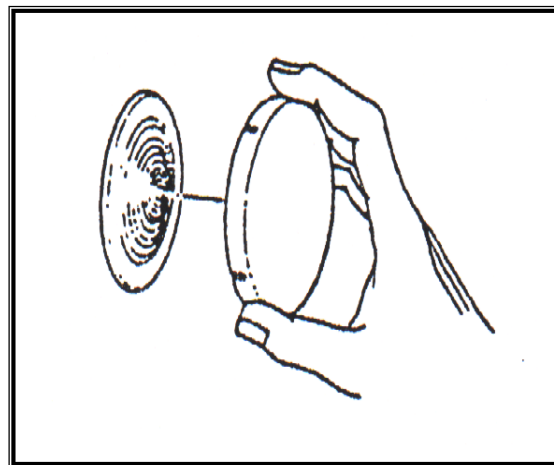

## Light Bulb Replacement

To replace the spa light bulb; turn ALL power to the Equipment Module OFF. Locate the rear of the spa light and remove the bulb sock by rotating socket counter clockwise 1/8 turn and pulling on the socket (not the wire), as shown below. Pull the bulb from the socket and replace by reversing the above steps.

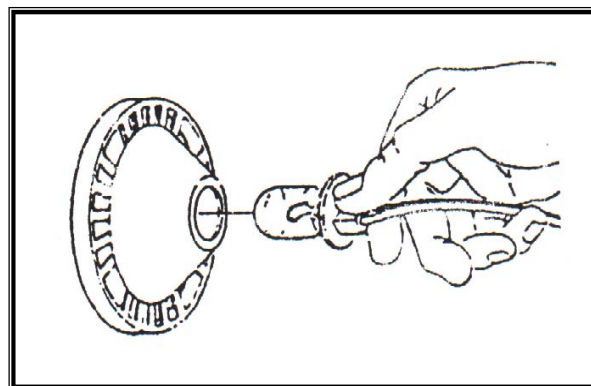

**CAUTION:** The replacement bulb must be the same rating as the factory installed bulb.

### **SPAVAC™ Kit – Optional**

Your QCA SPAVAC™ can be used with garden hose pressure or provided vacuum hose. Your QCA Majestic Spa is equipped with a wall skimmer. For use with garden hose, the SPAVAC™ is equipped with a fine mesh screen bag which can be easily cleaned after use. For use with the vacuum hose, remove bag from the suction chamber, vac hose adaptor is then snapped into place. All debris will be removed through filter system.

### **Spa Care and Maintenance**

It is recommended to completely drain the spa at least four times a year. Otherwise, the water becomes chemically "saturated" and no longer responds to regular chemical upkeep. The spa should also be drained before long periods of disuse, or for equipment repair.

### **Draining of Water**

*Because of the small water volumes involved with spas, sometimes it is much simpler and less expensive to drain the water than to adjust the water chemistry with chemical additives. To drain the spa, shut off the main breaker to your spa equipment pack. Use a wet/dry vac to remove the remaining amount of water.*

### **Options for Draining the Water**

1. Simply siphon water from spa with garden hose.
2. A sump pump may be used to pump water from spa.

### **Refilling your Spa**

1. Shut off the main breaker to your spa equipment pack.
2. Fill spa with water.
3. Turn Power back on, spa will automatically start to run and heat water to set temperature.

### **Your Water Care Program**

*Before adding chemicals to your spa, do a full water analysis with a test kit or ask your QCA Spa dealer to conduct the water test for you.*

Step 1: Always have the circulation system running before adding any chemicals. As you fill your spa to the level recommended by the manufacturer, add Chelating agent to prevent metal staining and to protect equipment against scale and corrosion. Circulate for one hour.

Step 2: "Balance" the water so that it is neither alkaline (scale forming) nor acidic (corrosive). Balanced spa water should be 7.2 - 7.8 on the pH scale, with total alkalinity (the measure of the ability of water to resist a change in pH) in the range of 80-120 parts per million (ppm).

- A. If pH is lower than 7.2, add pH UP
- B. If pH is higher than 7.8, add pH DOWN
- C. If total alkalinity is below 80, add ALKALINITY UP.

Step 3: Shock treats the water with non chlorine shock to destroy any organic contaminants that may have accumulated in the spa during filling.

Step 4: Add Clarifier to keep water sparkling clear. Circulate one hour.

Step 5: Prepare your disinfectant dispenser or feeder for use according to directions. A bromine residual of 2.0 - 4.0 ppm, as determined by your test kit, should be maintained at all times. Directions for using the bromine are indicated on the float ring.

*We suggest you follow a regular maintenance program to keep your spa water fresh and crystal clear.*

### **Daily Checklist**

1. Test for proper bromine level. Replenish spa floater dispenser or feeder with bromine tabs as needed. Proper bromine level should be maintained at 2.0 - 4.0 ppm.
2. Test pH levels and adjust if needed. If you are having difficulty-keeping pH properly balanced, it may be an indication that total alkalinity needs adjusting. Have your dealer test the water and adjust if needed.

### **Weekly Checklist**

1. Add Clarifier to help the filter remove small particles and to retain water clarity.
2. Add cleaning agent to protect your equipment against stains, scale and rust.
3. For spas located outdoors or subject to a great deal of sunlight add Algaecide to guard against algae.
4. Shock your spa weekly with Oxidizer to remove contaminants such as ammonia, body oils and foreign matter. Unless spa water is routinely shock treated, contaminants will accumulate to cause eye and skin irritation, odors and cloudy dull water appearance.
5. To eliminate and prevent foaming, add a small amount of NON FOAM as needed.

### **General Guidelines**

- **NEVER MIX CHEMICALS TOGETHER**
- Add only small amounts of each chemical at a time until the desired value is achieved. Do not exceed dosage rates on label directions.
- Keep spa free of debris and cover spa when not in use.
- Circulate the water for 2-4 hours each day to maintain proper filtration. Clean your filter with FILTER CLEANER every 1-2 months.
- Remove oils and grease around water line with a cleaner on a weekly basis.
- In heavily used spas, water should be drained and refilled every two months or whenever it becomes difficult to maintain proper chemical levels.

NOTE: Not maintaining your water can result in damage of your spa jets, filter, etc. This damage, due to incorrect water maintenance, is not covered under warranty.

## Filter Maintenance

*As with any water filtering system, the filter cartridges may become clogged with particles or with calcification that will result in reduced water flow. In your QCA Spa, it is important to maintain a clean, unobstructed filtering system. This not only provides the maximum performance from the hydrotherapy jets, but allows the 24 hour filtration system to function effectively. We recommend the filter cartridges be cleaned (either spraying clean with water or soaking to dissolve minerals) EVERY MONTH.*

**WARNING:** Failure to maintain the cartridges in a clean, unobstructed manner will result in reduced water flow through the heater assembly which may cause the Heater High Limit Thermostat to "trip". If this high limit "trip" occurs during sub-freezing temperatures and goes unnoticed, the spa water may freeze. Any damage to the spa (from freezing), which is a direct cause of poor maintenance, will not be covered by warranty.

## Removing the Filter Cartridge

*The cartridge of the in-line filter must be removed for cleaning. This is accomplished as follows:*

1. Remove filter lid.
2. Twist and lift built-in chemical dispenser and remove the cartridge.
3. Remove the filter cartridge from the housing and clean, or replace it with a new cartridge.

## Cleaning the Filter Cartridge

1. Hold the cartridge in an upright position and spray downward into the pleats of the fabric with a garden hose to flush away debris. Cleaning will be easier if the garden hose nozzle can be adjusted to a single jet spray.
2. After hosing off the cartridge, it is highly recommended that the cartridge be allowed to soak in a filter-cleaning solution available through your local dealer. Soak the cartridge for 24 hours to remove body oils and body lotions that become impregnated in the cartridge fabric during filtration. Rinse the cartridge thoroughly before placing it back in the filter housing.

*NOTE: If two filter cartridges are available, it is recommended to allow filter cartridge to dry before new usage.*

3. If the cartridge is coated with hard, solid material, it may indicate a calcium build-up on the fabric. This build-up can be removed by soaking the cartridge in proper cartridge cleaning solution available through your QCA

dealer. When using this solution, follow instructions provided on label.

4. If the cartridge is coated with algae or bacteria, it should be soaked in a solution of one part chlorine and four parts water in a plastic container. As a safety precaution, rubber gloves should be worn while handling this solution. Brushing the solution into the fabric pleats may also help remove algae or bacteria. Rinse the cartridge thoroughly before placing it back into the filter housing.

*Observe manufacturers recommended safety procedures when using acid or chlorine. Always rinse the cartridge thoroughly after applying these solutions.*

5. Clean the filter housing and filter housing O-ring. Lubricate the O-ring with silicone lubricant.
6. Return the filter cartridge to the housing and replace the housing lid.

## Vacation Care Instructions

*If you plan to be away, follow these instructions to maintain the water quality:*

### Short Time Periods (3-5 Days):

1. Adjust the pH by following the instructions outlined in the water quality and maintenance section.
2. Sanitize the water by following the "superchlorination" procedures and lock your thermal cover in place using the tie-downs.
3. Upon your return, sanitize the water (superchlorinate, if necessary) and balance the pH.

**IMPORTANT NOTE:** *Spa water oxidizers such as dichlor chlorine maintain their level of effectiveness substantially longer in cool water than in hot water.*

### Long Time Periods (4-15 Days):

Prior to leaving:

1. Adjust the pH as required.
2. Sanitize the water by following the SUPER-CHLORINATION procedures.
3. Upon your return, check the level of sanitation of your spa water. If the chlorine test reads "O" and you have been gone an extended period of time, SUPER-CHLORINATE the spa water to ensure all organisms or algae are oxidized. Turn the Temperature Control clockwise to return it to the original setting. The spa water will be safe for you to use once the Free Chlorine Residual has dropped below 5.0 ppm.

## Prevention of Freezing

The QCA Spa has been designed and engineered for year-round use in any climate. The energy efficiency of the spa may decrease during these cold periods, as the heater will cycle more frequently. If a freeze condition is detected, the

low-speed pump is automatically activated. This is a normal spa function; no corrective action is necessary. Freeze protection is enabled regardless of the spa's status.

### **Winterizing**

In very cold weather you may not want to venture outside to use your spa. In this case, you may move it to a heated area, or leave it as is until the weather warms. If you do leave the spa unused for a long period of time in severely cold weather, you should winterize the spa to avoid accidental freezing due to a power or equipment failure.. Follow these easy steps: Turn power to the spa OFF. Drain the spa. Use a wet vac to suck or blow out the air injectors, water jets and water suction fittings. Add 1-3 gallons of RV antifreeze, depending on the size of the spa, to all the air injectors, water jets, suction drains, and filter. **Caution: Any lines not receiving adequate antifreeze are subject to freeze damage!**

### **Spa and Cabinet Maintenance**

Acrylic Finish - The acrylic finish on all QCA spas is impervious to most of the problems associated with non-acrylic finished spas and requires very little effort to keep it looking bright and clean. Every four months the spa should be drained, cleaned, polished and refilled. For the cleaning, use any non-abrasive cleaner. There are several non-abrasive

products on the market that can be used for polishing. Made specifically for acrylic spas are cleaner/polish/sealer combinations, which contain reactive silicones instead of wax. If these are not available, any high quality silicone automotive polish will suffice.

**Weather Guard® Cabinet Care** – Handcrafted maintenance free cabinet surfaces may need to be wiped down from time to time with a soap and water solution or simply sprayed with a garden hose. Use of harsh chemicals to clean the surface will cause the cabinet to discolor.

**Redwood Spa Cabinet Care** - Your spa cabinet is handcrafted of clear redwood. Unfortunately all woods exposed to weather and moisture may warp to some degree. However if you wish to retain your cabinet's original deep rich look and protect it from warpage, we recommended applying a good quality wood protector and moisture sealant. The spa's environment such as the amount of light, or humidity, will determine how often repeat applications are required. Consult your local hardware store for wood finishing products and their proper application.

<p><i>PLEASE NOTE:</i> We cannot be responsible for any moisture damage to your redwood cabinet. <b>For your protection, cabinets must be moisture sealed.</b></p>
--

### **WARRANTY REGISTRATION**

**This warranty applies to spas manufactured by QCA MAJESTIC™ Spas and sold to an original consumer purchaser at retail ("Purchaser") after May 1, 1998. To validate this warranty, the Purchaser must complete the enclosed warranty registration card and mail it to QCA MAJESTIC™ within 30 days of deliver of the spa. RETURN OF THE OWNER REGISTRATION CARD IS A CONDITION OF WARRANTY COVERAGE. This warranty is exclusive and supersedes all other representations or obligations of QCA Spas, Inc. MAJESTIC™, whether express or implied and whether oral, written or printed.**

Your Serial Number is located inside shell on the step or under shell hanging from plumbing within the equipment compartment of your QCA Spa.

Date Purchased:

Date Installed:

Dealer:

Address:

Telephone:

Spa Model :

Serial Number:

**Warning:** Elderly persons, infants and anyone subject to heart disease, diabetes, high or low blood pressure, strokes, epilepsy or similar afflictions should not enter a spa alone and without consulting a physician. Unsupervised use by children should be prohibited. Never use a spa while under the influence of alcohol, anti-coagulants, antihistamines, vasoconstrictors, vasodilators, stimulants, hypnotics, narcotics, or tranquilizers. If you are taking medications of any kind, or being treated for any illness, consult your physician prior to the use of the spa. A spa should be kept at temperatures less then 104° F or 40° C for personal safety and health.

**To validate your warranty the enclosed warranty must be filled out and returned to QCA Spas, Inc. within 30 days from date of purchase.**

**For your warranty see enclosed packet located inside your spa shell.**

**To receive your FREE gift to help maintain your spa and to VALIDATE your spa warranty, return the PREPAID registration card below within the next thirty days. To immediately register your new spa; you may log onto our web site at [qcaspas.com](http://qcaspas.com).**